

Varenummer: 03449040
 Beskrivelse: Fluro Heavy Duty Ledleje GE 40 SWE
 Hul Ø40
 Note: 40

Mål

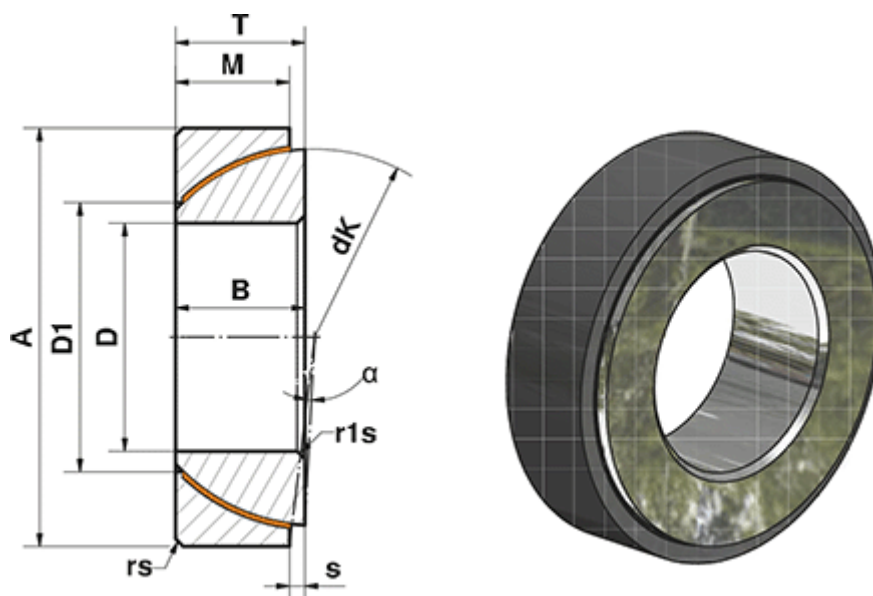

A	= 68	rs, r1s min	= 1
a (grader)	= 3.5	S	= 2.8
B	= 19	Statisk belastning C0 (kN)	= 424
D	= 40	T	= 19
D1	= 47.7	Vægt (g)	= 327
dK	= 62		
Dynamisk belastning C (kN)	= 254		
M	= 17		